





For Low Pressure

Mold Cupla

General purpose and mold coolant port coupling

Working pressure  1.0MPa (10kgf/cm ²)	Valve structure  One-way shut-off	 Straight through	Applicable fluids  Water  Heated oil
--	---	---	---

Designed for quick replacement for die and mold !
Rust resistant models having many variations.

- Space saving design for molds with closely spaced coolant ports.
- Long sleeve socket facilitates connection/disconnection with plug embedded in mold.
- Various sizes and end configurations to suit a wide variety of mold applications.
- Can be connected with Super Cuplas, excluding K3 and K4 types.
- Push-to-connect design. (Built-in automatic shut-off valve)
Also available is Cupla without valve. (please specify the basic model).

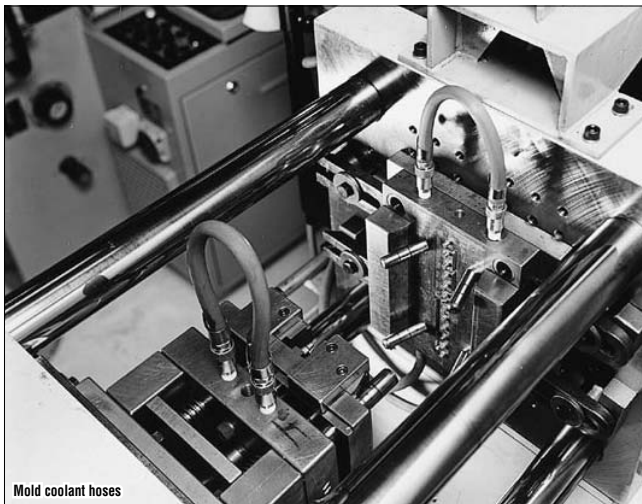

Mold coolant hoses

Specifications

Body material	Brass		
Size	1/8" • 1/4" • 3/8"		
Working pressure MPa (kgf/cm ²)	1.0 (10)		
Pressure resistance MPa (kgf/cm ²)	1.5 (15)		
Seal material Working temperature range	Seal material	Mark	Working temperature range
	Nitrile rubber	NBR (SG)	-20°C~+80°C
	Fluoro rubber	FKM (X-100)	-20°C~+180°C
			Remarks
			Standard material
			Available on request

Max. Tightening Torque

N·m (kgf·cm)

Size	1/8"	1/4"	3/8"
Torque	5 (51)	9 (92)	11 (112)

Flow Direction

Fluid may flow in either direction from plug or from socket side when coupled.



Interchangeability

Sockets and plugs can be connected regardless of end configurations and sizes. Can be connected to Super Cupla.

Min. Cross-Sectional Area

(mm²)

Plug	Socket	K02SH	K03SH	K02SM	K03SM	K02SF	K02SHL	K03SHL
K02PH		15.5	15.5	15.5	15.5	15.5	15.5	15.5
K03PH		15.5	28	28	28	28	15.5	28
K01PM		15.5	23	23	23	23	15.5	23
K02PM		15.5	28	28	28	28	15.5	28
K03PM		15.5	28	28	28	28	15.5	28
K01PF		15.5	28	28	28	28	15.5	28
K02PF		15.5	28	28	28	28	15.5	28
K03PF		15.5	28	28	28	28	15.5	28
K01PML		15.5	19	19	19	19	15.5	19
K02PML		15.5	28	28	28	28	15.5	28
K03PML		15.5	28	28	28	28	15.5	28

Suitability for Vacuum

Not suitable for vacuum application in either connected or disconnected condition.

Plug Embedment Dimensions

(mm)

Model	D*	C*	L	Remarks
K01PM	20 or more	0~3	28	* Socket interference prevents connection/disconnection when C exceeds 3mm.
K02PM	20 or more	0~3	29	* Size D should be bigger than the outer diameter of the socket wrench to be used.
K03PM	20 or more	0~3	30	(See JISB4636-1, JISB4636-2)

Flow Rate – Pressure Loss Characteristics

[Test conditions] • Fluid : Water • Temperature : Room temperature

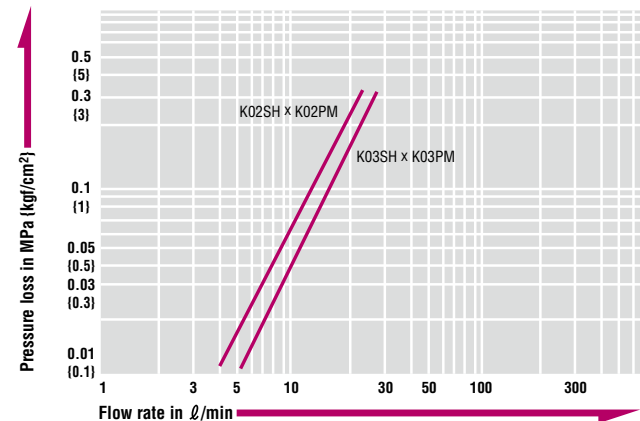

Models and Dimensions

Plug PH type (Hose barb)

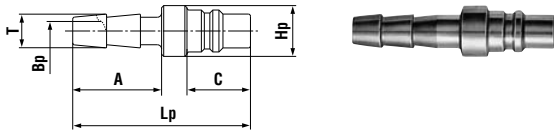

Model	Application (Hose)	Mass (g)	Dimensions (mm)					
			Lp	A	C	øHp	øT	øBp
K02PH	1/4"	17	42	21	15	12	8	4.5
K03PH	3/8"	19	42	21	15	15	12	6

Plug PM type (Male thread)

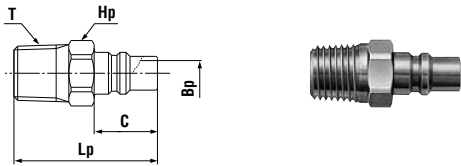

Model	Application	Mass (g)	Dimensions (mm)				
			Lp	Hp(WAF)	C	T	øBp
K01PM	Rc 1/8	14	31	Hex.12	15	R 1/8	5.5
K02PM	Rc 1/4	20	34	Hex.14	15	R 1/4	6
K03PM	Rc 3/8	35	35	Hex.17	15	R 3/8	6

Plug PF type (Female thread)

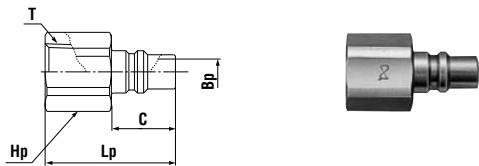

Model	Application	Mass (g)	Dimensions (mm)				
			Lp	Hp(WAF)	C	T	øBp
K01PF	R 1/8	16	28	Hex.14	15	Rc 1/8	6
K02PF	R 1/4	22	30.5	Hex.17	15	Rc 1/4	6
K03PF	R 3/8	35	32	Hex.21	15	Rc 3/8	6

Plug PML type (With L-shaped male thread)

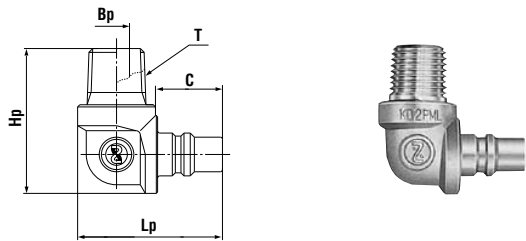

Model	Application	Mass (g)	Dimensions (mm)				
			Lp	C	Hp	T	øBp
K01PML	Rc 1/8	43	33.5	15	30.5	R 1/8	5
K02PML	Rc 1/4	53	33.5	15	33.5	R 1/4	6
K03PML	Rc 3/8	71	33.5	15	33.5	R 3/8	6

Socket SH type (Hose barb)

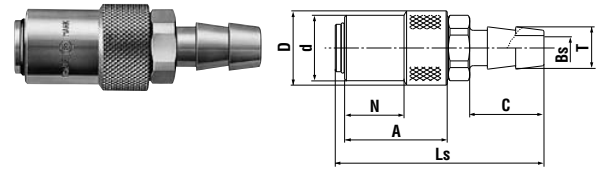

Model	Application (Hose)	Mass (g)	Dimensions (mm)							
			Ls	øD	ød	N	A	C	øT	øBs
K02SH	1/4"	52	(67)	21	18.5	16.8	29	29	8	5
K03SH	3/8"	60	(59)	21	18.5	16.8	29	21	12	7

Socket SM type (Male thread)

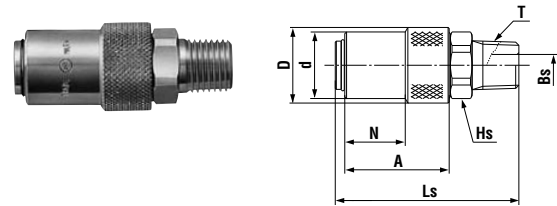

Model	Application	Mass (g)	Dimensions (mm)							
			Ls	øD	ød	N	A	Hs(WAF)	T	øBs
K02SM	Rc 1/4	70	(51)	21	18.5	16.8	29	Hex.17	R 1/4	6
K03SM	Rc 3/8	82	(52)	21	18.5	16.8	29	Hex.19	R 3/8	6

Socket SF type (Female thread)

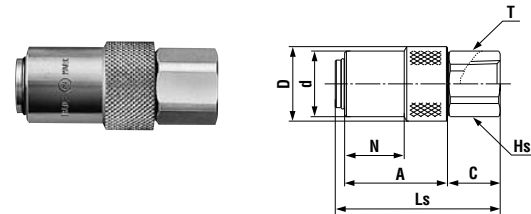

Model	Application	Mass (g)	Dimensions (mm)							
			Ls	øD	ød	N	A	C	T	Hs(WAF)
K02SF	R 1/4	57	(46.5)	21	18.5	16.8	29	14.5	Rc 1/4	Hex.17

Socket SHL type (With L-shaped hose barb)

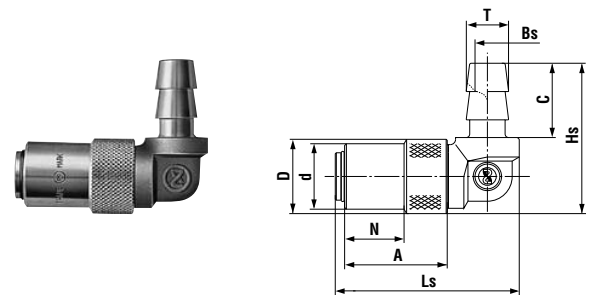

Model	Application	Mass (g)	Dimensions (mm)								
			Ls	øD	ød	N	A	C	øT	Hs	øBs
K02SHL	1/4"	79	(52)	21	18.5	16.8	29	21	8	(42.5)	4.5
K03SHL	3/8"	87	(52)	21	18.5	16.8	29	21	12	(42.5)	7





Notes: Also available without socket valve, identified by product code TS (e.g. K03SH without valve is K03TSH). Also available are Cuplas with sleeve stopper (Made-to-order item).

For Low Pressure

Mold Cupla

High flow type

High flow type mold coolant port coupling

Working pressure  1.0MPa (10kgf/cm ²)	Valve structure  One-way shut-off	Applicable fluids  Water	 Heated oil
 Straight through			

Flow rate has doubled to contribute to productivity.

- High flow type K3 and K4 series are added to mold Cupla series for mold coolant and heated oil port coupling.
- Almost double flow rate compared with our standard K01, K02, and K03 series contributing to productivity.
- Space saving design for molds with closely spaced coolant ports.
- Long sleeve socket facilitates connection/disconnection with plug embedded in mold.
- Enables quick mold coolant hose connection/disconnection.

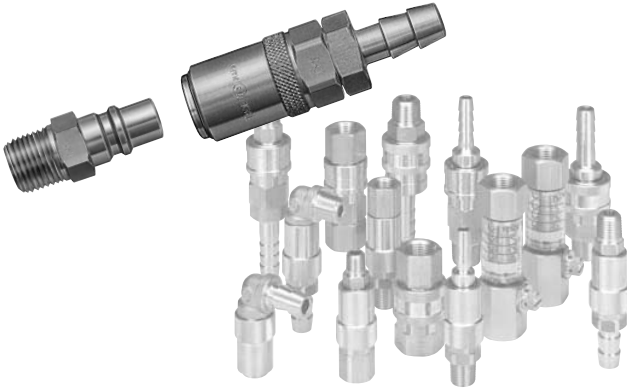

Plug Embedment Dimensions (mm)

Model	D*	C*	L	Remarks
K3-02PM	24 or more	0~3	31	* Socket interference prevents connection/disconnection when C exceeds 3mm.
K3-03PM	24 or more	0~3	31	* Size D should be bigger than the outer diameter of the socket wrench to be used.
K4-04PM	32 or more	0~3	39	(See JISB4636-1, JISB4636-2)

Models and Dimensions

Plug		PM type (Male thread / High flow type)						
Model	Application	Mass (g)	Dimensions (mm)					
			Lp	C	Hp(WAF)	øE	øT	øBp
K3-02PM	Rc 1/4	16	36	17.5	Hex.14	15.5	R 1/4	9
K3-03PM	Rc 3/8	25	36	17.5	Hex.17	18.5	R 3/8	9.5
K4-04PM	Rc 1/2	50	46	21.5	Hex.22	24	R 1/2	13

Notes: Also available without socket valve, identified by product code TS (e.g. K03SH without valve is K03TSH)
Also available are Cuplas with sleeve stopper. (Made-to-order item)

Specifications

Body material	Brass		
Size	1/4" • 3/8" • 1/2"		
Working pressure MPa (kgf/cm ²)	1.0 {10}		
Pressure resistance MPa (kgf/cm ²)	1.5 {15}		
Seal material Working temperature range	Seal material	Mark	Working temperature range
	Nitrile rubber	NBR (SG)	-20°C~+80°C
	Fluoro rubber	FKM (X-100)	-20°C~+180°C
		Remarks	Standard material Available on request

Max. Tightening Torque N·m (kgf·cm)

Size	1/4"	3/8"	1/2"
Torque	9 {92}	11 {112}	20 {204}

Flow Direction

Fluid may flow in either direction from plug or from socket side when coupled.



Interchangeability

In K3 series sockets and plugs can be connected regardless of end configurations and sizes. In K4 series sockets and plugs can be connected regardless of end configurations and sizes. K3 series and K4 series can neither be connected with other mold Cuplas series, nor with K3 series and K4 series each other.

Min. Cross-Sectional Area (mm²)

Plug \ Socket	K3-03SH	K3-04SH	K4-04SH
K3-02PM	38	63.5	—
K3-03PM	38	70.5	—
K4-04PM	—	—	78.5

Suitability for Vacuum

Not suitable for vacuum application in either connected or disconnected condition.

Flow Rate – Pressure Loss Characteristics

[Test conditions] • Fluid : Water • Temperature : Room temperature

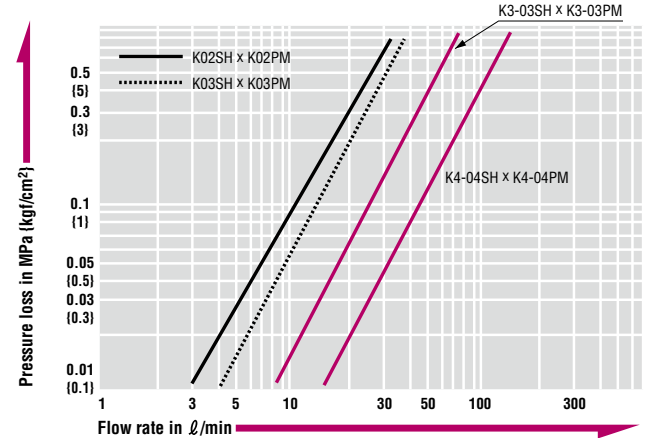

WAF : WAF stands for width across flat.

Socket SH type (Hose barb / High flow type)

Socket		SH type (Hose barb / High flow type)							
Model	Application (Hose)	Mass (g)	Dimensions (mm)						
			Ls	øD	ød	N	A	øT	øBs
K3-03SH	3/8"	100	(65)	24	22.5	19	25.5	12	7
K3-04SH	1/2"	102	(67)	24	22.5	19	25.5	15	10
K4-04SH	1/2"	226	(82)	32	30	26.5	34	15	10

Before use, please be sure to read "Safety Guide" described at the end of this book and "Instruction Sheet" that comes with the products.