

# Compressor

## Model **DAH102-X1**

12 V DC

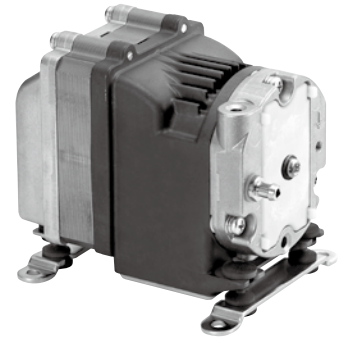

### Airflow & Electric Current

Airflow Characteristics

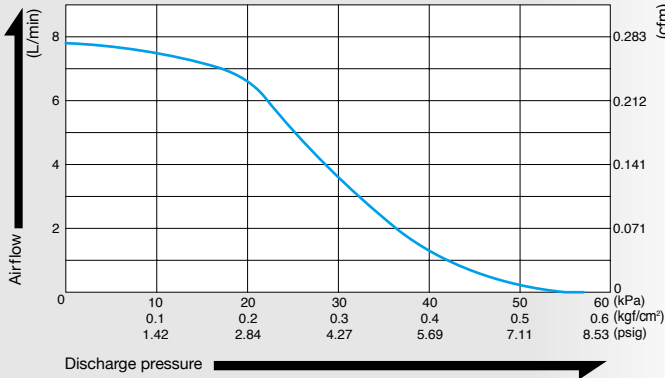

Current Characteristics

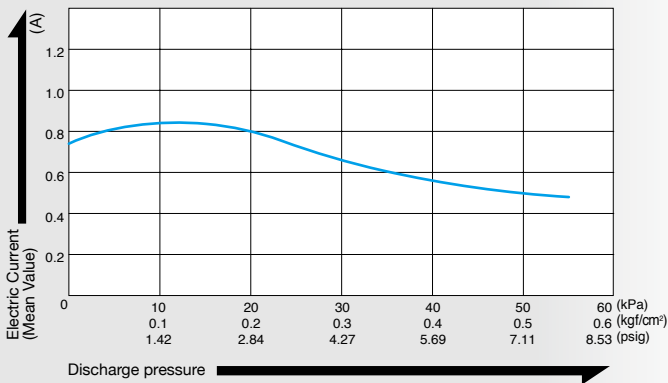

### Specifications

Rated Pressure	20 kPa (0.2 kgf/cm <sup>2</sup> ) 0.2 bar 2.84 psig
Rated Airflow	5 L/min *1 0.177 cfm
Maximum Pressure	50 kPa (0.5 kgf/cm <sup>2</sup> ) 0.5 bar 7.11 psig
Rated Voltage	12 V DC
Current (Mean Value)	0.81 A
Rated Performance (MTTF)	10,000 hours
Outlet	6 mm O.D. hose barb
Duty Cycle	Continuous
Coil Insulation Class	A or its equivalent
Mounting Dimensions	76 (L) x 70 (W) mm 2 - 63/64" (L) x 2 - 3/4" (W)
Weight	0.91 kg 2.01 Lbs
Leadwire Length	300 mm 11 - 13/16"

\*1: Airflow at rated pressure.

### Optional Accessory (LB07793)

Heavy duty rubber feet available on request.

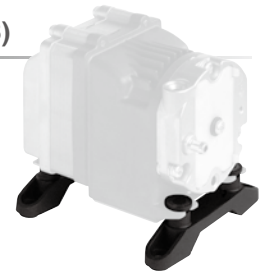

### Application Examples

Medical equipment, analyzers, etc.

### External Dimensions (Unit: mm)

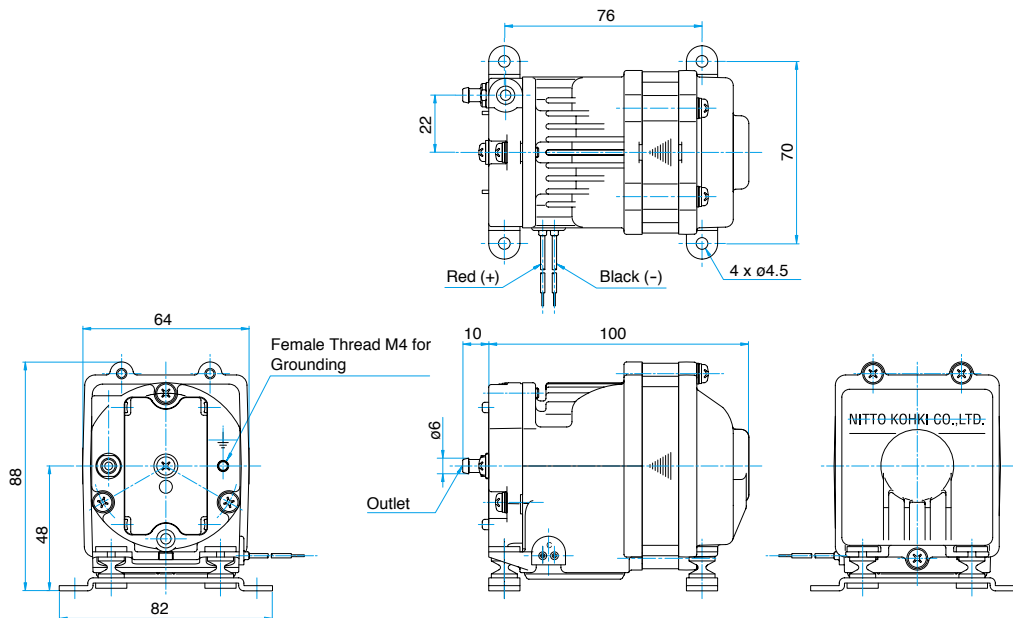

# Compressor

## Model **DAH102-Y1**

24 V DC

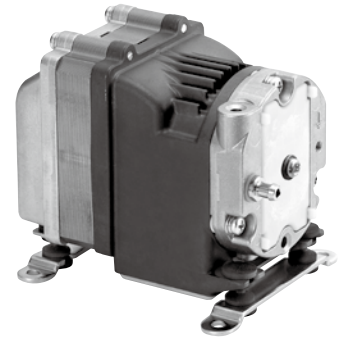

### Airflow & Electric Current

Airflow Characteristics

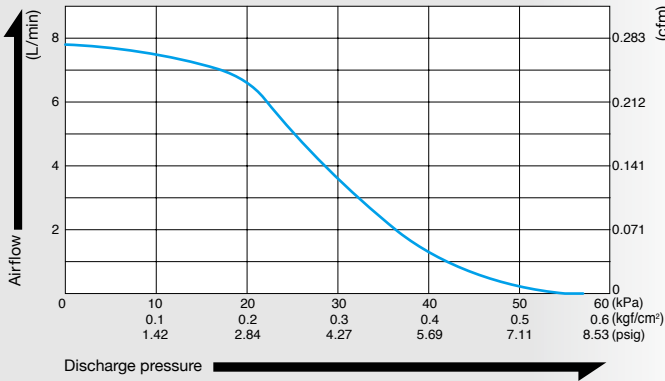

Current Characteristics

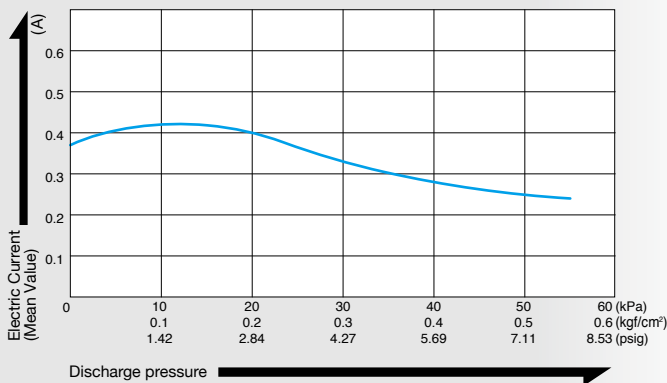

### Specifications

Rated Pressure	20 kPa (0.2 kgf/cm <sup>2</sup> ) 0.2 bar 2.84 psig
Rated Airflow	5 L/min *1 0.177 cfm
Maximum Pressure	50 kPa (0.5 kgf/cm <sup>2</sup> ) 0.5 bar 7.11 psig
Rated Voltage	24 V DC
Current (Mean Value)	0.40 A
Rated Performance (MTTF)	10,000 hours
Outlet	6 mm O.D. hose barb
Duty Cycle	Continuous
Coil Insulation Class	A or its equivalent
Mounting Dimensions	76 (L) x 70 (W) mm 2 - 63/64" (L) x 2 - 3/4" (W)
Weight	0.91 kg 2.01 Lbs
Leadwire Length	300 mm 11 - 13/16"

\*1: Airflow at rated pressure.

### Optional Accessory (LB07793)

Heavy duty rubber feet available on request.

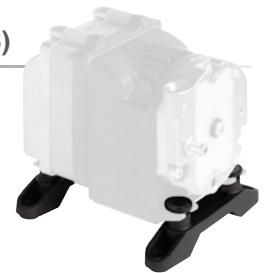

### Application Examples

Medical equipment, analyzers, etc.

### External Dimensions (Unit: mm)

