

# SUPER SAW SSW-110 ASSEMBLY AND PARTS LIST

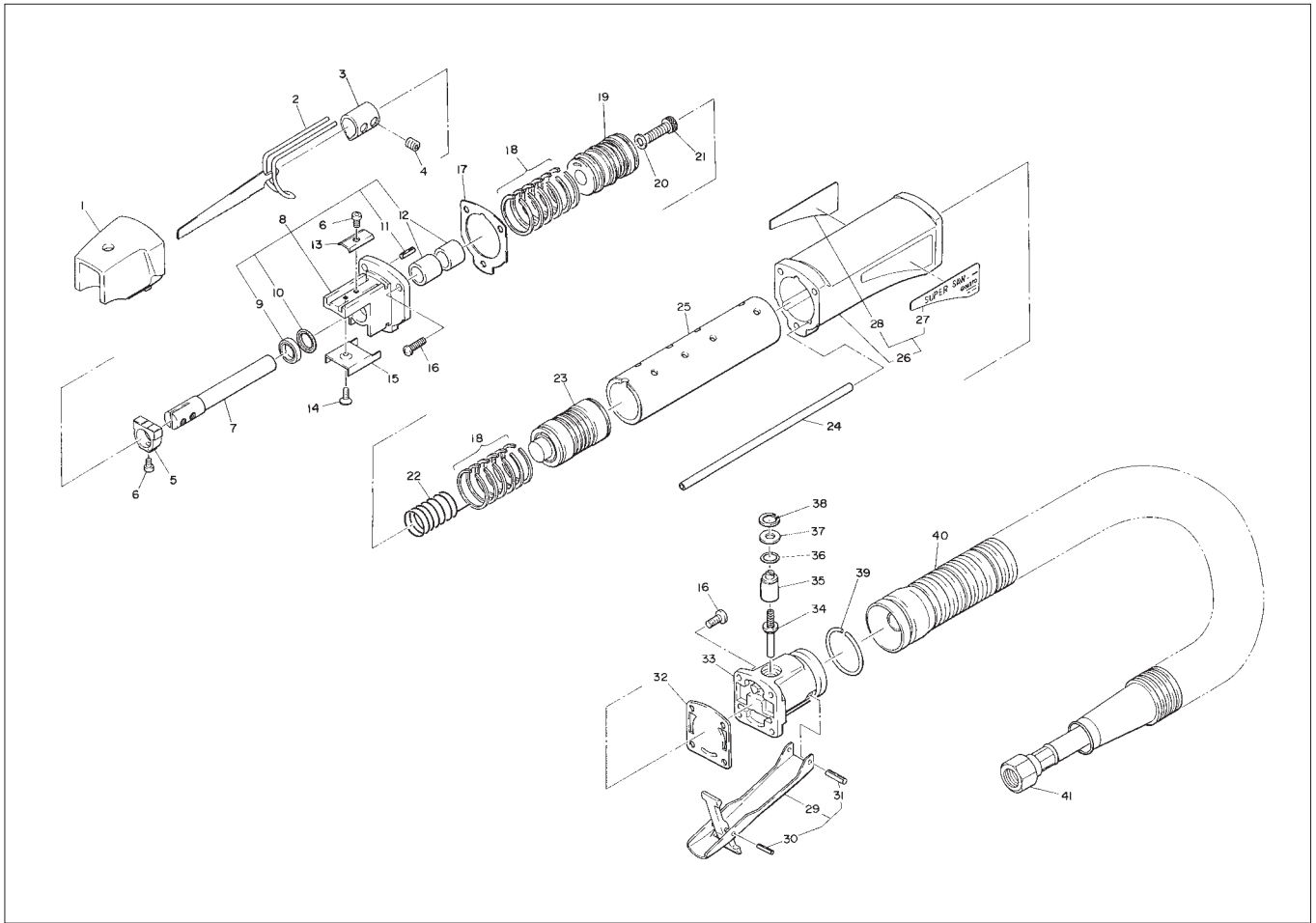

The Part Numbers with ( ) are included in the Ass'y parts written above them.

No.	Part No.	Part Name	Q'ty	Price
1	TQ01986	Cover	1	
2	TP16638	Supporter	1	
3	TQ02451	Collar 13	1	
4	TP06141	Hex. Socket Set Screw 6 X 6	2	
5	TQ01969	Guide	1	
6	CP20233	Hex. Socket Head Cap Screw 4 X 6	2	
7	TQ01968	Guide Shaft	1	
8	TB01654	Cylinder Head Sub Ass'y	1 set	
9	(TP03978)	Oil Seal G10 X 14 X 3	2	
10	(TA9A101)	U Seal Ass'y	1 set	
11	(TP01920)	Spring Pin 3 X 8	1	
12	(TQ01971)	Bush	2	
13	TQ01992	Supporter Plate	1	
14	TP02902	Cross Recessed Countersunk Flat Head Screw 3 X 6	1	
15	TQ01972	Guide Holder	1	
16	TP02638	Cross Recessed Pan Head Screw 4 X 12	7	
17	TQ01985	Packing B	1	
18	TB01653	Piston Ring Ass'y	2 set	
19	TQ01982	Piston B	1	
20	LP09810	Plain Washer M5	1	
21	TP01934	Hex. Socket Head Cap Screw 5 X 18	1	

No.	Part No.	Part Name	Q'ty	Price
22	TQ01987	Spring 1 X 17 X 42	1	
23	TB01399	Piston A sub Ass'y	1 set	
24	TQ01979	Tube	2	
25	TQ01978	Cylinder	1	
26	TB01841	Housing Sub Ass'y	1 set	
27	(TQ01976)	Name Plate	1	
28	(TQ02482)	Warning Label	1	
29	TB01388	Throttle Lever Ass'y	1 set	
30	(TP05498)	Spring Pin 2 X 16	1	
31	(TP00460)	Spring Pin 3 X 22	1	
32	TQ01984	Packing A	1	
33	TQ01974	Valve Body	1	
34	TA93070	Throttle Valve Ass'y	1 set	
35	TP06325	Adjust Valve	1	
36	TP11997	O-Ring KS-7	1	
37	TP06326	Spacer 6 X 12 X 1.2	1	
38	TP03695	Retaining Ring C-12	1	
39	TP09153	Stop Ring O-27 X 2.6	1	
40	TQ01664	Exhaust Hose	1	
41	TA96867	Air Hose Sub Ass'y 1/4	1 set	
	TP02236	Bushing PT1/4 X NPT1/14	1	
	TP16067	Saw Blade 32	2	
	TP04696	Hex. Wrench Key 3	1	
	TQ02483	Instruction Manual	1	