

Compressor and Vacuum Pump

Model **DPO110T-X1**



Brushless DC Motor 12 V DC



Airflow & Power Consumption

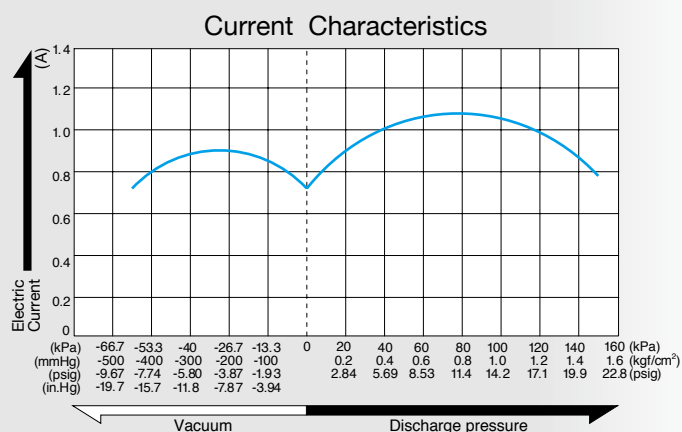
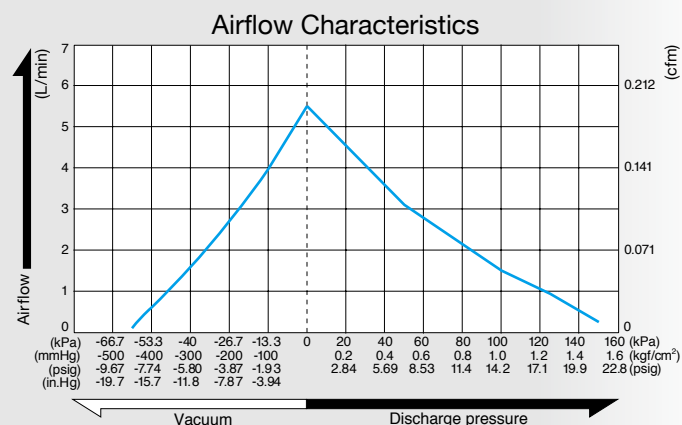

Specifications

Attainable Vacuum	-60.0 kPa (-450 mmHg) -600 mbar -17.7 in.Hg
Free Air Displacement	5.5 L/min 0.194 cfm
Rated Voltage	12 V DC
Maximum Pressure	150 kPa (1.5 kgf/cm ²) 1.5 bar 21.3 psig
Maximum Current	1.2 A or less
Duty Cycle	Continuous
Rated Performance (MTTF)	5,000 hours
Inlet	6.8 mm O.D. straight barb
Outlet	6.8 mm O.D. straight barb
Coil Insulation Class	A or its equivalent
Mounting Dimensions	36.5 (L) x 37.5 (W) mm 1 - 7/16" (L) x 1 - 15/32" (W)
Weight	0.27 kg 0.60 Lbs
Leadwire Length	360 mm 14 - 11/64"

Application Examples

Vending Machines

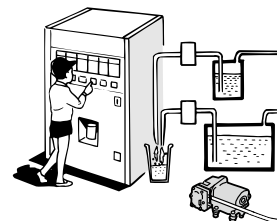

External Dimensions (Unit: mm)

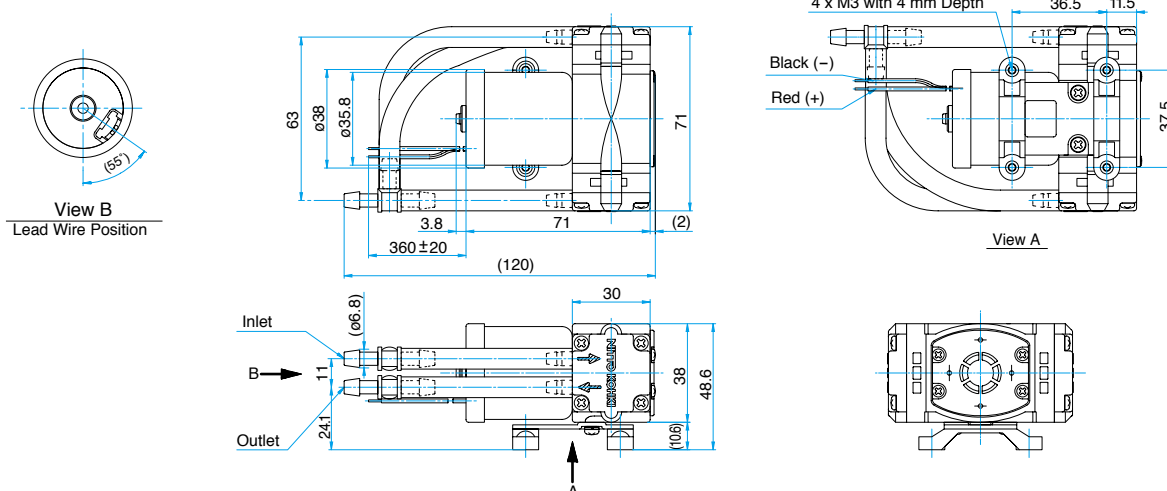

Compressor and Vacuum Pump

Model **DPO110T-Y1**



Brushless DC Motor

24 V DC

Airflow & Power Consumption

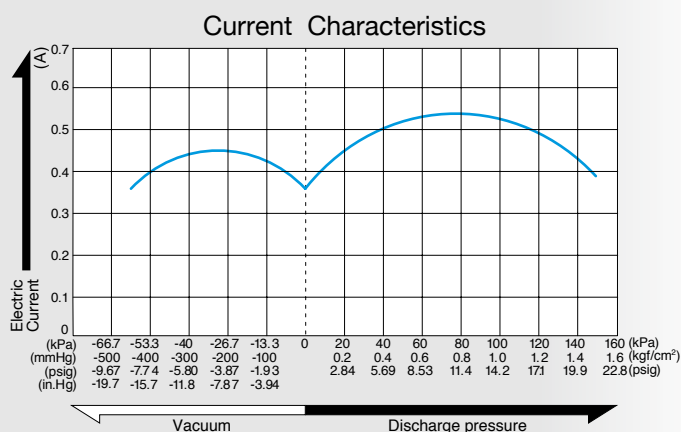
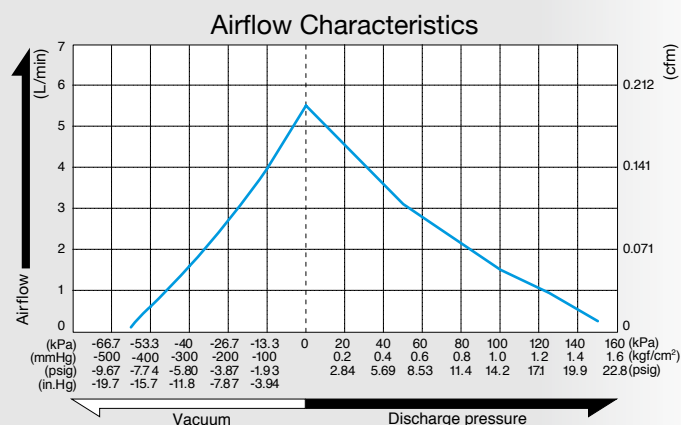

Specifications

Attainable Vacuum	-60.0 kPa (-450 mmHg) -600 mbar -17.7 in.Hg
Free Air Displacement	5.5 L/min 0.194 cfm
Rated Voltage	24 V DC
Maximum Pressure	150 kPa (1.5 kgf/cm ²) 1.5 bar 21.3 psig
Maximum Current	0.6 A or less
Duty Cycle	Continuous
Rated Performance (MTTF)	5,000 hours
Inlet	6.8 mm O.D. straight barb
Outlet	6.8 mm O.D. straight barb
Coil Insulation Class	A or its equivalent
Mounting Dimensions	36.5 (L) x 37.5 (W) mm 1 - 7/16" (L) x 1 - 15/32" (W)
Weight	0.27 kg 0.60 Lbs
Leadwire Length	360 mm 14 - 11/64"

Application Examples

Vending Machines

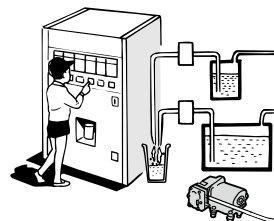

External Dimensions (Unit: mm)

