

# Vacuum Pump

## Model DVH130-X1 12 V DC

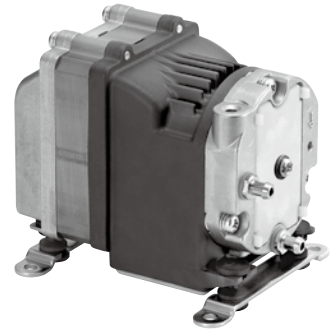

### Airflow & Electric Current

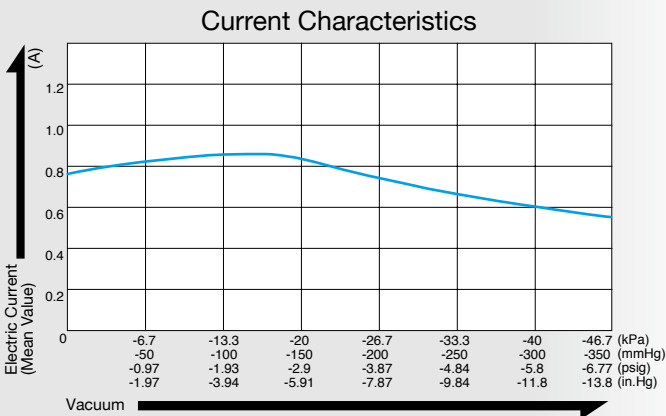
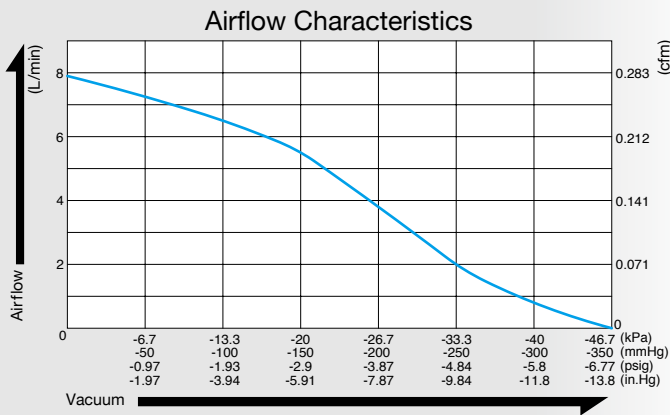

### Specifications

Attainable Vacuum	-40 kPa (-300 mmHg) -400 mbar -11.8 in. Hg
Free Air Displacement	7 L/min *1 0.247 cfm
Rated Voltage	12 V DC
Current (Mean Value)	0.86 A
Rated Performance (MTTF)	10,000 hours
Inlet	6 mm O.D. hose barb
Outlet	6 mm O.D. hose barb
Duty Cycle	Continuous
Coil Insulation Class	A or its equivalent
Mounting Dimensions	76 (L) x 70 (W) mm 2 - 63/64" (L) x 2 - 3/4" (W)
Weight	0.91 kg 2.01 Lbs
Leadwire Length	300 mm 11 - 13/16"

\*1: Free air displacement at no-load operation.

### Optional Accessory (LB07793)

Heavy duty rubber feet available on request.

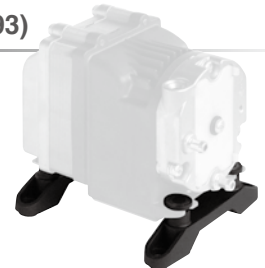

### Application Examples

Medical equipment, analyzers, etc.

### External Dimensions (Unit: mm)

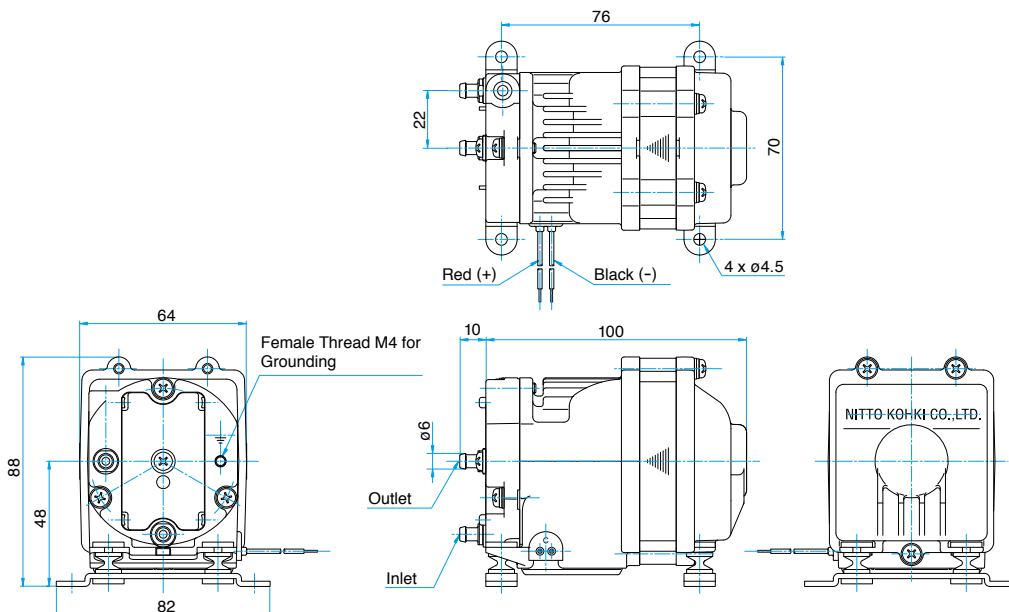

# Vacuum Pump

## Model DVH130-Y1

24 V DC

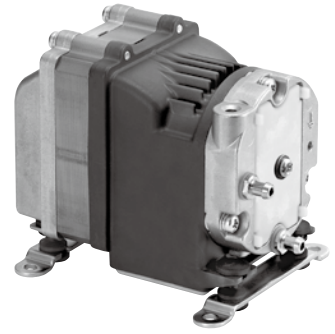

### Airflow & Electric Current

Airflow Characteristics

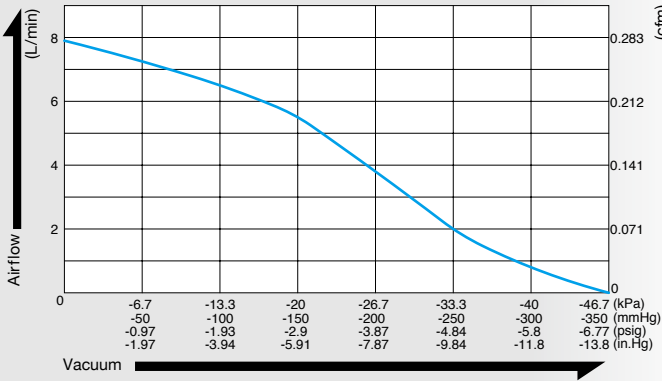

Current Characteristics

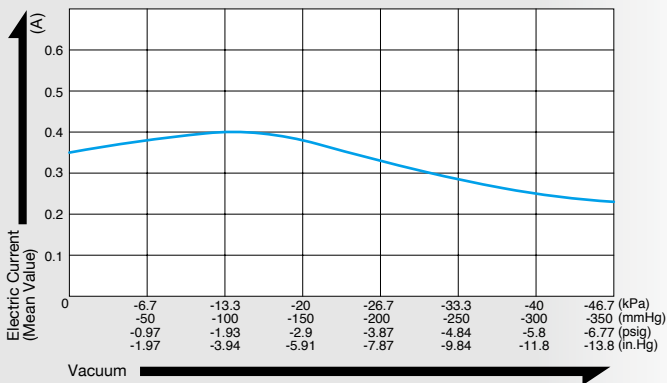

### Specifications

Attainable Vacuum	-40 kPa (-300 mmHg) -400 mbar -11.8 in. Hg
Free Air Displacement	7 L/min *1 0.247 cfm
Rated Voltage	24 V DC
Current (Mean Value)	0.41 A
Rated Performance (MTTF)	10,000 hours
Inlet	6 mm O.D. hose barb
Outlet	6 mm O.D. hose barb
Duty Cycle	Continuous
Coil Insulation Class	A or its equivalent
Mounting Dimensions	76 (L) x 70 (W) mm 2 - 63/64" (L) x 2 - 3/4" (W)
Weight	0.91 kg 2.01 Lbs
Leadwire Length	300 mm 11 - 13/16"

\*1: Free air displacement at no-load operation.

### Optional Accessory (LB07793)

Heavy duty rubber feet available on request.

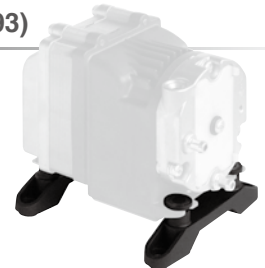

### Application Examples

Medical equipment, analyzers, etc.

### External Dimensions (Unit: mm)

